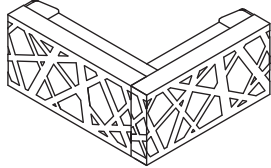
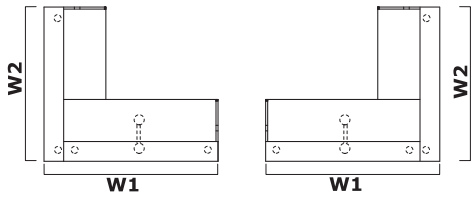
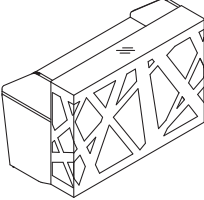
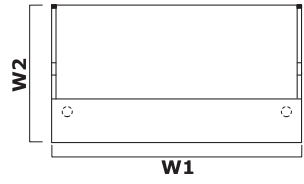
								
Symbol		Wymiary					Waga Obj. Opak.	Elementy składowe
		W1	W2	D1	D2	H		
LZG44		2480	2200			1146	276.2 kg 3.224 m3 14 szt.	LZN51+LZB22+2xLZG22+LZB22M+NL41

Dodatkowa dopłata						

 								
Symbol		Wymiary					Waga Obj. Opak.	Elementy składowe
		W1	W2	D1	D2	H		
LZG45		2480	2200			1146	283.2 kg 3.243 m3 15 szt.	LZN51+LZK01+2xLZG22+LZB22 +LZB22M+NL41

Dodatkowa dopłata						

 								
Symbol		Wymiary					Waga Obj. Opak.	Elementy składowe
		W1	W2	D1	D2	H		
LZG34		1600	880			1146	126.901 kg 1.245 m3 7 szt.	LZN51+LZK01+LZG16+LZB16
LZG46		2200	880			1146	156.9 kg 1.69 m3 8 szt.	LZN51+LZK01+LZG22+LZB22

Dodatkowa dopłata						

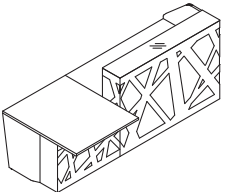
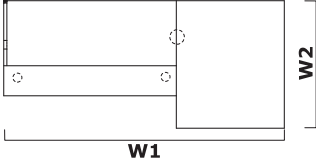
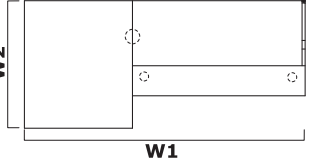
  								
Symbol		Wymiary					Waga Obj. Opak.	Elementy składowe
		W1	W2	D1	D2	H		
LZG50		2600	1180			1146	208.401 kg 1.798 m3 11 szt.	LZN51+LZG10+LZG16+LZB16 +LZK01+NE41L
LZG51		3200	1180			1146	238.4 kg 2.242 m3 12 szt.	LZN51+LZG10+LZG22+LZB22 +LZK01+NE41L

Dodatkowa dopłata					

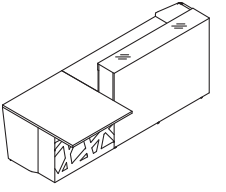
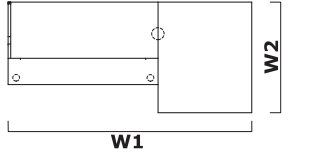
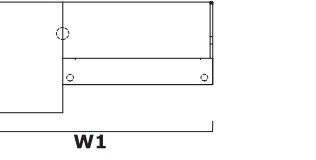
  								
Symbol		Wymiary					Waga Obj. Opak.	Elementy składowe
		W1	W2	D1	D2	H		
LZG56		2600	1180			1146	210.401 kg 1.798 m3 11 szt.	LZG10+LZG16M+LZB16+LZN51 +LZK01+NE41L

Dodatkowa dopłata					

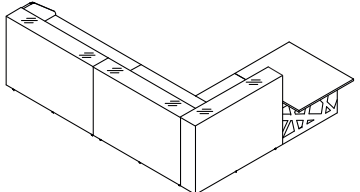
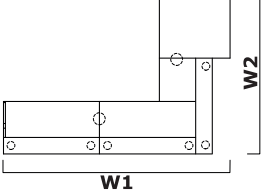
 								
Symbol		Wymiary					Waga Obj. Opak.	Elementy składowe
		W1	W2	D1	D2	H		
LZG57		3200	2880			1146	419.202 kg 4.153 m3 23 szt.	LZN51+LZG10+LZB16M+2xLZB16+3xLZG16M+LZK01+2xNE41L

Dodatkowa dopłata					

Symbol		Wymiary					Waga Obj. Opak.	Elementy składowe
		W1	W2	D1	D2	H		
LZG32		1600	1880			1146	217.501 kg 2.386 m ³ 12 szt.	LZB16M+2xLZG16+LZB16+LZN51

Dodatkowa dopłata						

Symbol		Wymiary					Waga Obj. Opak.	Elementy składowe
		W1	W2	D1	D2	H		
LZG35		1600	1880			1146	224.501 kg 2.405 m ³ 13 szt.	LZB16M+2xLZG16+LZB16+LZN51+LZK01

Dodatkowa dopłata						

Symbol		Wymiary					Waga Obj. Opak.	Elementy składowe
		W1	W2	D1	D2	H		
LZG36		2200	1880			1146	252.501 kg 2.799 m ³ 13 szt.	LZN51+LZK01+LZB22M+LZG22 +LZB16+LZG16

Dodatkowa dopłata						

Symbol		Wymiary					Waga Obj. Opak.	Elementy składowe
		W1	W2	D1	D2	H		
LZG38		2480	1600			1146	245.501 kg 2.779 m ³ 12 szt.	LZN51+LZB16+LZG22+LZB22M +LZG16

Dodatkowa dopłata						

Symbol		Wymiary					Waga Obj. Opak.	Elementy składowe
		W1	W2	D1	D2	H		
LZG40		2480	1600			1146	252.501 kg 2.799 m ³ 13 szt.	LZN51+LZK01+LZB16+LZG22 +LZB22M+LZG16

Dodatkowa dopłata						

Symbol		Wymiary					Waga Obj. Opak.	Elementy składowe
		W1	W2	D1	D2	H		
LZG42		2480	1600			1146	252.4 kg 2.849 m ³ 11 szt.	LZN51+LZK01+LZB22+LZG22 +LZB16M+LZG16+NL41

Dodatkowa dopłata						

Symbol		Wymiary					Waga Obj. Opak.	Elementy składowe
		W1	W2	D1	D2	H		
LZG58		3808	2880			1146	415.202 kg 4.153 m ³ 23 szt.	LZN51+LZK01+2xLZB16+2xLZG16+LZG16M+LZB16M+LZG10N +2xNE41L

Dodatkowa dopłata						

Symbol		Wymiary					Waga Obj. Opak.	Elementy składowe
		W1	W2	D1	D2	H		
LZG52		4200	1180			1146	314.802 kg 2.991 m ³ 17 szt.	LZN51+LZK01+LZB16+LZG16 +LZG10+LZG16+LZB16+2xNE41L
LZG53		4800	1180			1146	344.801 kg 3.435 m ³ 18 szt.	LZN51+LZK01+LZB16+LZG16 +LZG10+LZG22+LZB22+2xNE41L
LZG54		5400	1180			1146	374.8 kg 3.88 m ³ 19 szt.	LZN51+LZK01+LZB22+LZG22 +LZG10+LZG22+LZB22+2xNE41L

Dodatkowa dopłata						

Symbol		Wymiary					Waga Obj. Opak.	Elementy składowe
		W1	W2	D1	D2	H		
LZG55		4200	1180			1146	307.802 kg 2.971 m ³ 16 szt.	LZN51+LZB16+2xLZG16+LZG10 +LZB16+2xNE41L

Dodatkowa dopłata						

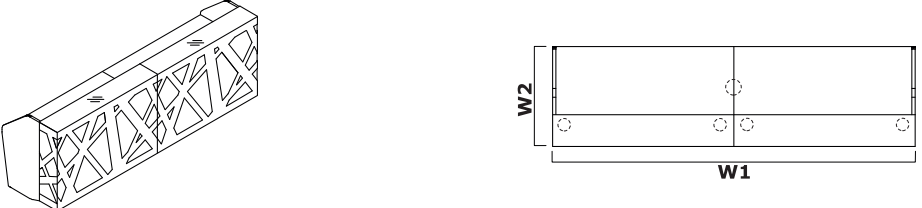

Symbol		Wymiary					Waga Obj. Opak.	Elementy składowe
		W1	W2	D1	D2	H		
LZG60		3200	880			1146	233.302 kg 2.438 m3 13 szt.	LZN51+LZK01+LZB16+LZG16 +LZB16+LZG16+NE41L
LZG61		3800	880			1146	263.301 kg 2.882 m3 14 szt.	LZN51+LZK01+LZB16+LZG16 +LZB22+LZG22+NE41L
LZG62		4400	880			1146	293.3 kg 3.327 m3 15 szt.	LZN51+LZK01+LZB22+LZG22 +LZB22+LZG22+NE41L

Dodatkowa dopłata						

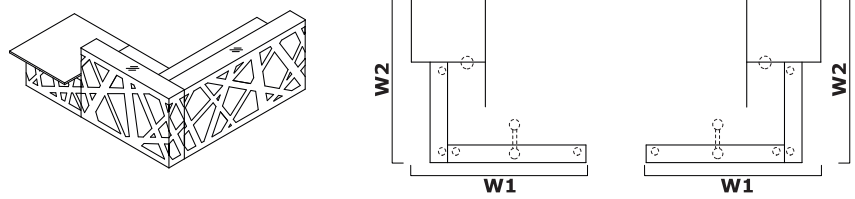

Symbol		Wymiary					Waga Obj. Opak.	Elementy składowe
		W1	W2	D1	D2	H		
LZG64		2600	2780			1146	328.3 kg 3.383 m3 16 szt.	LZN51+LZB22+LZG22+LZG16 +LZB16M+LZG10+NL41+NE41L

Dodatkowa dopłata						

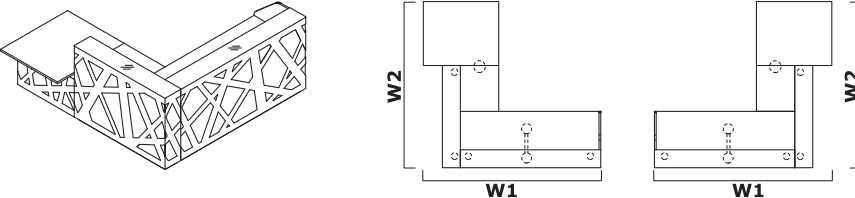

Symbol		Wymiary					Waga Obj. Opak.	Elementy składowe
		W1	W2	D1	D2	H		
LZG63		2600	2780			1146	335.3 kg 3.402 m3 17 szt.	LZN51+LZK01+LZB22+LZG22 +LZG16+LZG16M+LZG10+NL41+NE41L

Dodatkowa dopłata						

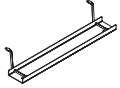
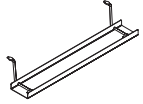
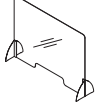
Elementy składowe							
	Symbol		Wymiary			Waga Obj. Opak.	Uwagi
			Szer.	Gł.	Wys.		
	NL41		585	142	712	2 kg 0.063 m3 1 szt.	noga okrągła
	E64L		460	89	120	0.5 kg 0.001 m3 1 szt.	kanał kablowy M009 - aluminium półmat
	S69L		580	162	123	1 kg 0.015 m3 1 szt.	09 - aluminium
	NPX1		1000	250	750	3 kg 0.01 m3 2 szt.	nadstawka ochronna, tworzywo PET bezbarwne + stopki metalowe, kolor: M009 - aluminium półmat

Dodatkowa dopłata							